



シャーシにワンタッチで固定する基板スペーサー Snap-mount PCB spacer

特長 Features

- 基板とシャーシを固定・スペーシングする2つの機能を備えています。
- Provides simultaneous functions of spacing and supporting for PCB and chassis.

材料 Material

- ナイロン66 (色調：ナチュラル) **UL94 V-2 (V-0)***
- Nylon 66 (Color : Natural)

※ V0タイプは品番末尾に“V0”が付きます。
(ロット数・納期はお問い合わせ下さい。)

For V0 type, “V0” is added to the end of the part No.
(With regard to lot size and lead time, please contact us.)



スナップ取付 / Snap Mounting



Round hole
丸孔

セットで使用可能 KGPS-Sシリーズ
重量のある基板などを、中間部で支持します。



Can be used with KGPS-S series
Supports heavily loaded PC boards at the middle of PCB

KGLS-S

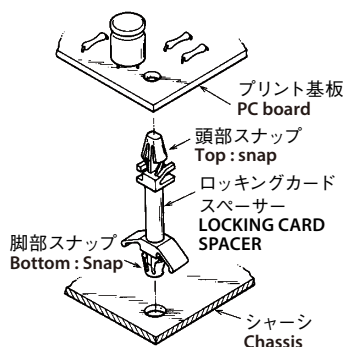
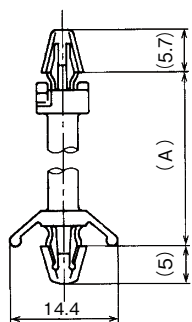

品番 Part No.	(A)	取付孔 Mounting hole size	取付板厚 Panel thickness	包装単位 Std. Package
KGLS-3S	9.8	頭部/Top $\phi 4^{+0.2}$	頭部/Top 1~2	100 個/pcs.
KGLS-4S	11.4			
KGLS-6S	14.4			
KGLS-8S	17.7			
KGLS-10S	20.9			
KGLS-12S	24.1	脚部/Bottom $\phi 4.8^{+0.2}$	脚部/Bottom 0.5~2.3	
KGLS-14S	27.2			
KGLS-16S	30.4			
KGLS-18S	33.6			
KGLS-22S	39.9			

(単位/Unit : mm)

KGLS-7S

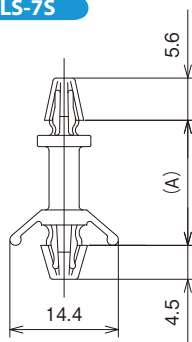

品番 Part No.	(A)	取付孔 Mounting hole size	取付板厚 Panel thickness	包装単位 Std. Package
KGLS-7S	16.6	頭部/Top $\phi 4^{+0.2}$ 脚部/Bottom $\phi 4.8^{+0.2}$	頭部/Top $\leq t1.8$ 脚部/Bottom 0.5~2.3	1,000 個/pcs.

(単位/Unit : mm)

KLCS

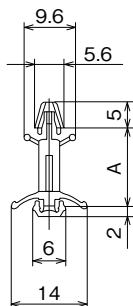

品番 Part No.	A	取付孔 Mounting hole size	取付板厚 Panel thickness	包装単位 Std. Package
KLCS-4H	12.0	頭部/Top $\phi 4^{+0.2}$	頭部/Top 0.8~1.3	200 個/pcs.
KLCS-6	14.4	脚部/Bottom $\phi 4.8^{+0.2}$	脚部/Bottom 0.5~1	100 個/pcs.

(単位/Unit : mm)

KGLS-1S

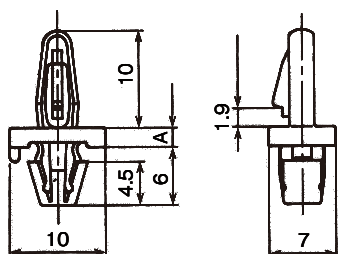

脚部取付仕様図

Specification drawing for bottom holes

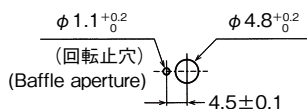

品番 Part No.	A	取付孔 Mounting hole size	取付板厚 Panel thickness	包装単位 Std. Package
KGLS-1S	2.0	頭部/Top $\phi 4^{+0.2}$ 脚部/Bottom $\phi 4.8^{+0.2}$ ※回転止穴必要 ※Baffle aperture is required.	頭部/Top 1.7 脚部/Bottom $1.2^{+0.15}$	1,000 個/pcs.

(単位/Unit : mm)

ロックン グ カードスペーサー™

(2/2)

LOCKING CARDSPACER™ / KGLS™-S·KLCS·KGSL-M

KGSL-1M-V0

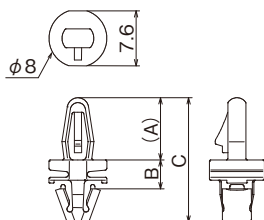

品番 Part No.	(A)	B	C	取付孔 Mounting hole size	取付板厚 Panel thickness	包装単位 Std. Package
KGSL-1M-V0	8.6	4.0	17.2	頭部/Top $\phi 4^{+0.2}_0$ 脚部/Bottom $\phi 4.8^{+0.2}_0$	頭部/Top 1.6 ± 0.1 脚部/Bottom 1 ± 0.1	1,000 個/pcs.

(単位/Unit : mm)

KGSL-1.5M-V0

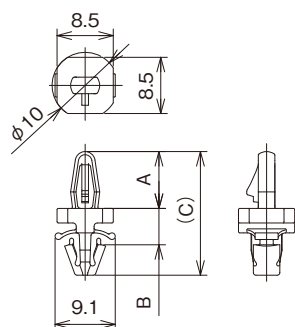

品番 Part No.	A	B	(C)	取付孔 Mounting hole size	取付板厚 Panel thickness	包装単位 Std. Package
KGSL-1.5M-V0	8.6	5.5	18.7	頭部/Top $\phi 4 \pm 0.1$ 脚部/Bottom $\phi 4.8^{+0.2}_0$	頭部/Top $1.6 \sim 1.8$ 脚部/Bottom $1.0 \sim 1.6$	1,000 個/pcs.

(単位/Unit : mm)

KGSL- * M-V0

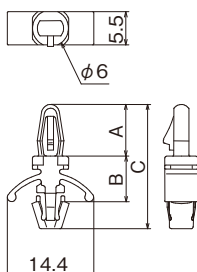

品番 Part No.	A	B	C	取付孔 Mounting hole size	取付板厚 Panel thickness	包装単位 Std. Package
KGSL-2M-V0	8.6	7.6	20.7	頭部/Top $\phi 4^{+0.2}_0$ 脚部/Bottom $\phi 4.8^{+0.2}_0$	頭部/Top 1.6 ± 0.1 脚部/Bottom $0.5 \sim 1.3$	1,000 個/pcs.
KGSL-3M-V0		8.4	21.5			100 個/pcs.
KGSL-5M-V0		11.6	24.7			100 個/pcs.
KGSL-7M-V0		13.2	26.3			

(単位/Unit : mm)